

KT 2039A

DUAL Digit Display

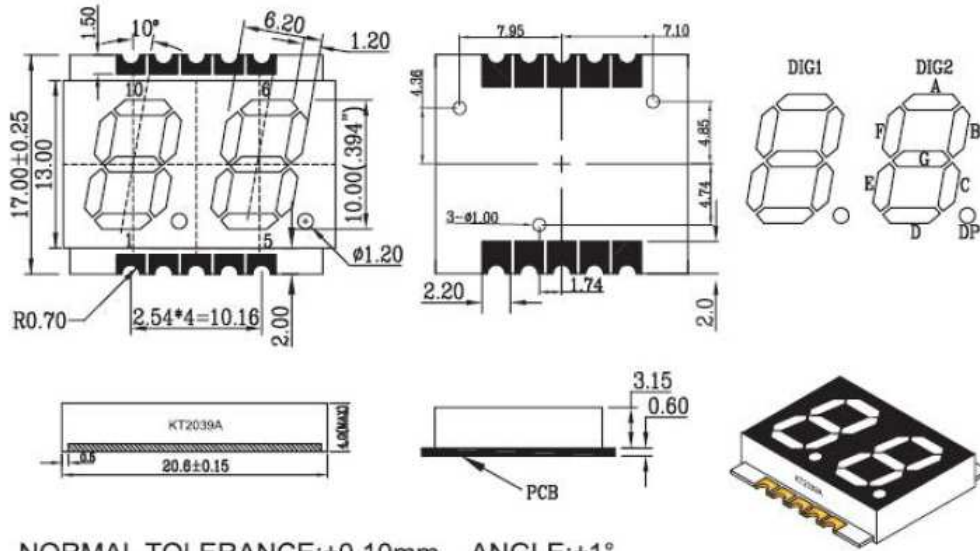

NORMAL TOLERANCE:±0.10mm ANGLE:±1°

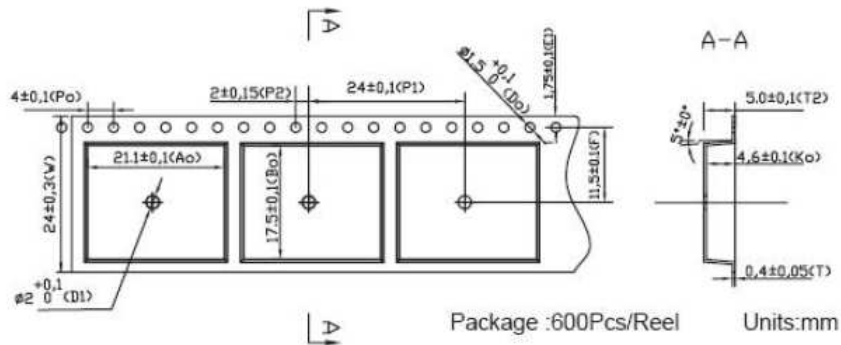

CODE E

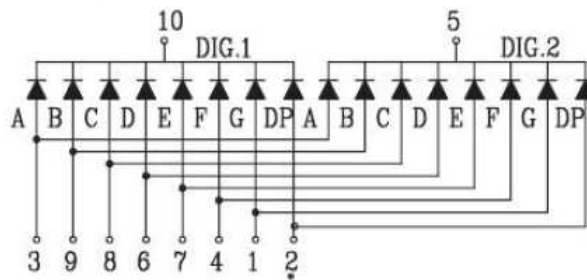

CODE B

